

STORAGE

**DynaMO 640SZI  
SCSI Internal Kit**

**INSTALLATION GUIDE**

**FUJITSU**

---

## CONTENTS

---

About This Guide	2
Unpacking your DynaMO Drive	2
Getting Started	3
Configure Switch Settings	4
Mounting the DynaMO Drive	6
Positioning the DynaMO Drive	8
Installing Driver Software	8
How to use the DynaMO Optical Disk Drive	9
Maintenance and Handling	10
Troubleshooting	11
Technical Specifications	12

## ABOUT THIS GUIDE

This guide provides instructions for complete installation of the Fujitsu DynaMO 640SZI in a desktop PC or Macintosh including instructions for using cartridges with the drive.

## UNPACKING YOUR DYNAMO DRIVE

640 MB SCSI drive (MCC3064SS),  
mounting hardware and faceplate

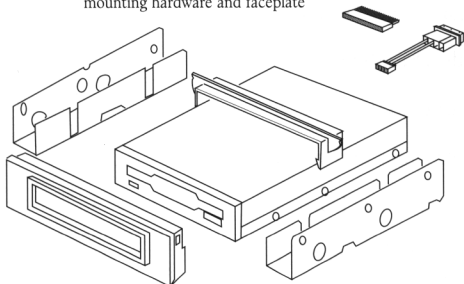

User's Guide

No Excuses  
Guide

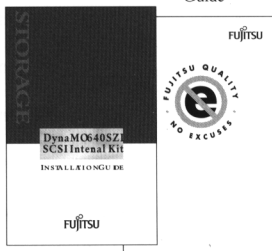

Power cable



640 MB media

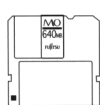

SCSI cable

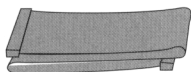

Companion CD



CD-ROM Driver



### Contents Listings

- MCC3064SS
- Fujitsu unformatted 640MB MO media
- Frame kit with brackets, bezel and retaining clip
- SCSI cable
- Power cable (standard peripheral power cable)
- Fujitsu CD-ROM with installation software and drivers
- DynaMO Companion Software CD-ROM
- Software Architects' Disk Drive Tune-up and Utility for the Macintosh
- Installation Guide
- No Excuses<sup>SM</sup> Warranty Guide and Warranty Registration Card
- Macintosh installation kit flyer

Check that you have received all of the items listed and that they are undamaged. If any of the items are damaged or missing, contact your reseller immediately.

Retain original packaging for future use should you need to transport the drive.

## GETTING STARTED

Before beginning the install process for this drive, you must ensure that the SCSI host adapter card is correctly installed and operational. Please consult the SCSI host adapter card manual or call the manufacturer if you require assistance. If available, wear a grounded wrist strap and use antistatic padding on all surfaces.

1. Turn off computer.



**Important:** Be sure to unplug your computer from the power source before removing the cover. Failure to do so could result in an electrical shock hazard to you.

2. Remove the system cover or casing.

- Do not connect or disconnect cables or reset drive switches when the computer is powered on.

3. Discharge static electricity. Touch one of the connectors on the back of your computer or ground yourself on a metal object to discharge any static electricity from your body.



**Important:** If you do not discharge static electricity from your body before touching the disk drive, damage to the drive could result.

4. Proceed to "Configure Switch Settings".

# CONFIGURE SWITCH SETTINGS

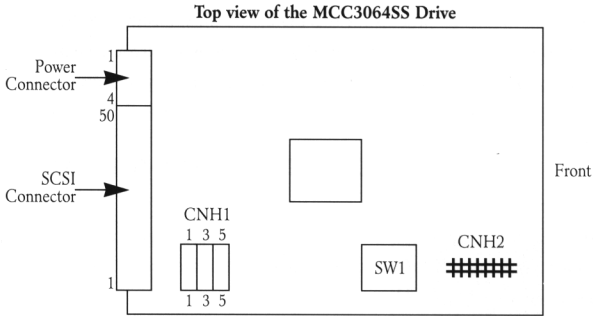

The illustration above shows the MCC3064SS drive switch locations. Configure switches as shown below for SW1. Then refer to the tables below and select a SCSI ID number that is not being used by any other device in your system.

## SW1

Switch 1 sets the SCSI ID and some drive functions. If your system has two or more SCSI devices, each must have a unique ID. The illustration shows the recommended settings for IBM PC, Macintosh and UNIX computers. These settings work for the majority of systems. See the SW1 Settings illustration below which details all possible SW1 settings.

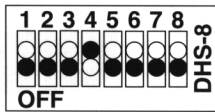

Typical for Most Platforms

SCSI ID and Drive Function Settings (SW1) Table

Key #	Function	Key On	Key Off
01	SCSI ID (see table below)	—	—
02			
03			
04	SCSI data bus parity check	Enabled	Disabled
05	Write cache	Enabled	Disabled
06	Device type mode	MO	Fixed disk
07	Download mode	Enabled	Disabled
08	Factory mode	Reverse	Normal

SCSI ID Table

SCSI ID	SW1-01	SW1-02	SW1-03
0 (default)	Off	Off	Off
1	Off	Off	On
2	Off	On	Off
3	Off	On	On
4	On	Off	Off
5	On	Off	On
6	On	On	Off
7	On	On	On

## CONFIGURE SWITCH SETTINGS (continued)

### CNH1 – Termination power

Switch CNH1 uses short bars to set the termination power source and to enable or disable termination. Pins 1 through 4 set whether power is supplied by drive power, by the host system, or by both. When shorted, pins 5 and 6 enable termination; when open, termination is disabled.

See "Configuration and SCSI Termination" for information on setting termination.

### Configurations and SCSI Termination

The figure below illustrates the termination requirements when connecting the DynaMO drive and other SCSI devices to a host system. The device at each end of a SCSI daisy chain must be terminated.

For the DynaMO drive, termination is enabled by shorting pins 5 and 6 on CNH1. The drive is shipped with termination enabled. If you install the DynaMO drive in the middle of a SCSI daisy chain, remove the shorting bar between pins 5 and 6 on CNH1 to disable the termination.

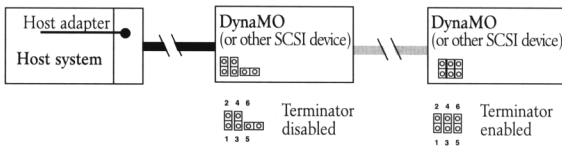

## FOR CONNECTION TO EXTERNAL ENCLOSURE (CNH2)

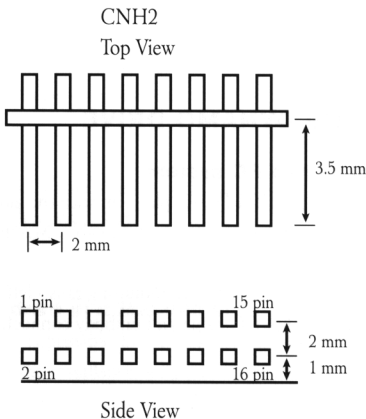

## External operator panel connector interface

Signal	Pin	Reference setting signal	Function
SCSI ID 4	2	SW1-01	Equivalent to ON position of SW1-01 by shorting with 0 V.
SCSI ID 2	4	SW1-02	Equivalent to ON position of SW1-02 by shorting with 0 V.
SCSI ID 1	6	SW1-03	Equivalent to ON position of SW1-03 by shorting with 0 V.
Device type mode	9	—	Equivalent to ON position by shorting with 0 V.
Spindle automatic stop mode	10	—	Equivalent to ON by shorting with 0 V.
Macintosh mode	11	—	Equivalent to ON position by shorting with 0 V.
Verify mode	13	—	Equivalent to ON position by shorting with 0 V.
Logical type-0	14	—	Equivalent to ON position by shorting with 0 V.
SCSI terminating resistor mode	15	CNH1(5-6)	Equivalent to shorting CNH1 05-06 by shorting with 0 V.
+LED	3	—	LED+terminal for external connection
-LED	5	—	LED-terminal for external connection
*EJSW	7	—	External eject instruction input (TTL-IC level) L level: Equivalent to pushing eject switch H level: Equivalent to not pushing eject switch
CTRGIN	1	—	External cartridge sensor output (TTL-IC level) L level: No cartridge in drive H level: Cartridge in drive
0 V (GND)	8, 12, 16	—	0 V

## MOUNTING THE DYNAMO DRIVE

### Mounting the drive in a PC system

The DynaMO will run on the IBM PC/AT platform with the aid of a SCSI-2 host adapter card and a compatible 50-pin SCSI cable. Macintosh systems come equipped with SCSI ports.

The included mounting kit comes with two mounting rails - left and right - plus a face plate, retaining clip, DC cable and unibody connector.

## MOUNTING THE DYNAMO DRIVE (continued)

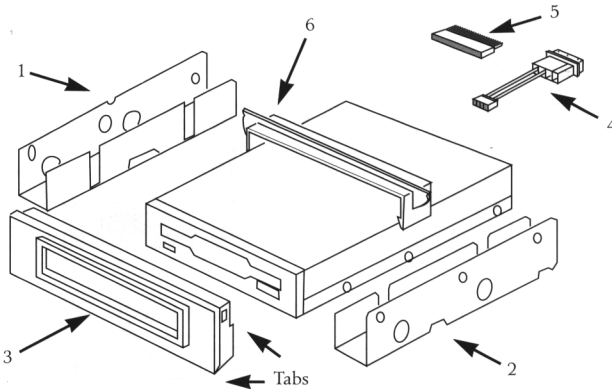

1. Attach the left rail (1) to the face plate (3). Insert bottom tab first, then repeat process for the right rail (2).
2. Slide the disk drive into position aligning the bottom holes of the disk drive with posts of the bracket assembly. Verify that no gaps are present on the faceplate.
3. Align the disk drive retaining clip (6) over the center of the disk drive as pictured. Slightly flex the drive clip and push down until both clip tabs engage the slots on the bottom of each rail. Use the screws provided to further secure the brackets to the disk drive if desired, however, this is not a necessary step.
4. Do not tilt the drive more than 15° above level during operation.
5. Connect the drive to the SCSI controller card using the included SCSI cable.
6. Connect the power cable to the drive.
7. Fasten the assembled drive with mounting kit to the 5 1/4" slot using the screws supplied in the frame kit.
8. Replace your system's cover or casing.



**Note:** The DC cable (4) and the Unibody connector (5) are not needed for the installation of the DynaMO 640SZI.

### Mounting the drive in a Macintosh

Due to the numerous possible Macintosh configurations, multiple installation solutions exist. For the installation instructions for mounting the DynaMO 640SZI into a Macintosh system, please refer to the instructions included with Macintosh frame kits available through distribution. Instructions are also available on Fujitsu's web site: [www.fcps.com](http://www.fcps.com).



## POSITIONING THE DYNAMO DRIVE

The drive can be positioned in one of the following ways applicable to your system:

### Vertical mount

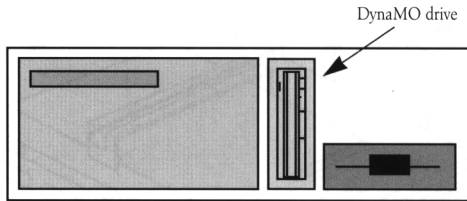

### Horizontal mount

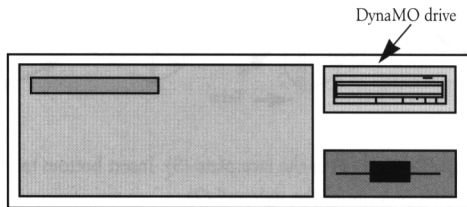

## INSTALLING DRIVER SOFTWARE

Your DynaMO 640SZI drive comes with software drivers for Windows 3.1, Windows 95, Windows NT 4.0 and OS/2. Follow the procedures below depending on which operating system you are running.

### Device Driver Installation:

1. Turn on the DynaMO 640SZI (green power indicator light will be lit).
2. Turn on computer and close all applications.
3. Insert the DynaMO CD into your CD-ROM drive, and click on the CD-ROM icon.
4. Select the appropriate folder for your operating system and click on "setup.exe" to install the software.
5. Follow the instructions to install your software.
6. Remove the CD and reboot the computer.



**MacOS Users.** The DynaMO CD does not contain Macintosh device drivers or a Macintosh MO disk formatter. Please refer to the set-up instructions in the "Disk Drive Tune Up" packet.

### Macintosh OS installation:

1. Insert Software Architects' Disk Drive Tune Up diskette into floppy drive
2. Double-click the Installer icon and click Continue.
3. Follow the instructions on your screen.
4. When the installation is complete, remove the disk and restart your computer.

You are now ready to use your DynaMO 640SZI.

## INSTALLING DRIVER SOFTWARE (continued)

### DynaMO Companion Software CD

The DynaMO Companion Software CD contains a variety of useful applications to further enhance your DynaMO experience.

You are responsible for the installation, management and operation of these applications. Fujitsu Computer Products of America makes no representations or warranties for the software included on the CD. All warranties, representations or support are provided by third parties and are described in the end user license agreement(s) included on the CD.

## HOW TO USE THE DYNAMO OPTICAL DISK DRIVE

The illustration below shows the DynaMO front panel. Insert cartridges in the drive as you would a floppy disk cartridge. The LED will light to indicate disk access.

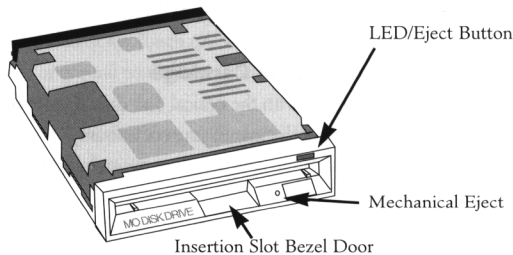

1. Insert media, label side up. If media will not go in, do not force. Check to see that the spring-loaded bezel door is open before installing the cartridge.
2. LED should blink during access.
3. Eject media using the eject button or a software command.
4. Refer to Troubleshooting section on page 11 if you encounter problems.

To write protect a disk, locate the write protect switch on the bottom side of the disk cartridge. Push the slide switch upwards towards the disk edge.

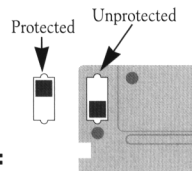

### Cartridges can be ejected in three ways:

1. By pressing the Eject button on the front of the drive.
2. By issuing a software eject command from the host system.
3. By mechanically inserting a paper clip or media extraction tool into the hole just below the shutter door.



**Important:** Never eject cartridge mechanically except in an emergency. If you eject a cartridge mechanically, do not move the drive until you have turned power on, inserted a cartridge, and ejected the cartridge using method 1 or 2 as noted above.

## MAINTENANCE AND HANDLING

This information will help to ensure trouble-free operation of the DynaMO 640SZI. Read it carefully.



**Important:** Do not connect or disconnect cables or reset drive switches when the PC is powered on.

Before moving the drive, be sure that:

1. The host system is turned off.
2. No cartridge is in the drive.

### Host System Environment and Drive Storage

Both the host system environment and drive storage locations should meet the environmental specifications listed under technical data on page 12. In particular, avoid quick changes in temperature to minimize condensation risks. Retain packaging materials for storage and transportation of drive.

### Maintenance of Optical Disk Cartridge

See the documentation supplied with the optical disk cartridge for information on cartridge care and handling, and the manufacturer's warranty.

## TROUBLESHOOTING

If you are experiencing problems with operation of the DynaMO 640SZI, try these suggestions.

<b>Symptom</b>	<b>Possible Solution</b>
Drive not recognized	<ul style="list-style-type: none"><li>• Make sure drive is powered on and a cartridge is inserted.</li><li>• Make sure drive is on a flat surface and tilt angle does not exceed 15° specification.</li><li>• Make sure SCSI ID is not conflicting with another SCSI device on the same bus.</li></ul>
Not writing to drive	<ul style="list-style-type: none"><li>• Make sure the write protect tab on the optical disk is not enabled.</li></ul>
Not writing to drive/ Not reading data	<ul style="list-style-type: none"><li>• Clean the media using the media cleaning kit. (Note: Do not clean new media)</li></ul>
Cartridge does not eject	<ul style="list-style-type: none"><li>• Check bezel shutter (flap) for clearance.</li></ul>

If these suggestions do not solve the problems you are experiencing, contact your Fujitsu authorized reseller or the Fujitsu Customer Support Center at (800) 626-4686. You will also find helpful technical information at our web site: <http://www.fcpa.com>.

For more information on Fujitsu Magneto-Optical Drives, please write to or call any of the following help lines/forums.

<b>Address:</b>	Fujitsu Computer Products of America, Inc. 2904 Orchard Parkway San Jose, CA 95134-2009 Voice: (408) 432-6333
<b>Internet WWW:</b>	<a href="http://www.fcpa.com">http://www.fcpa.com</a>
<b>Customer Support:</b>	Voice: (800) 626-4686 Fax: (408) 436-7066 Email: <a href="mailto:info@fcpa.fujitsu.com">info@fcpa.fujitsu.com</a>
<b>Fujitsu Direct - To purchase accessories and supplies</b>	Voice: (800) 735-4510
<b>Automated Factsback - For automated facsimile documents</b>	Fax: (408) 428-0456

## TECHNICAL SPECIFICATIONS

### MCC3064SS Drive Specifications

Capacity	640MB
Latency time	8.3 ms
Rotational speed	3,600 RPM
Density	52,900 bpi
	23,090 tpi
Loading time	7 sec.
Unloading time	5 sec.
Load/unload life	50,000
Interface	SCSI-2
Data transfer rate	
Drive	Up to 3.9 MB/s
Interface (maximum)	10 MB/s (sync)
	5 MB/s (async)
Cache	2MB
Power requirements	100 – 240 VAC, 50/60 Hz
Power consumption	
Operating	5.3 W
Sleep	0.9 W
Dimensions (HxWxD)	25.4 x 101.6 x 146.0 mm
Weight	460 g
Temperature	5° to 45° C
Relative humidity	10 to 85% (noncondensing)
Vibration	0.4G (5 to 500 Hz)
Altitude	3,000 m (10,000 ft)

### Media Specifications

Total capacity	128MB	230MB	540MB	640MB
Unformatted	181MB	325MB	819MB	818MB
Formatted	128MB	230MB	538MB	643MB
Capacity/track				
Unformatted (bytes)	18,100	18,100	18,100	43,928
		(logical track capacity)	(logical track capacity)	(logical track capacity)
Formatted (bytes)	12,800	12,800	12,800	34,816
		(logical track capacity)	(logical track capacity)	(logical track capacity)
Data transfer rate (max.)	1.09 MB/s	1.3 to 2.1 MB/s	2.33 to 3.92 MB/s	2.32 to 3.9 MB/s
Average seek time	28 ms typ	28 ms typ	28 ms typ	28 ms typ
Number of sectors/track	25	25	25	17



FUJITSU COMPUTER PRODUCTS OF AMERICA, INC.

2904 Orchard Parkway

San Jose, CA 95134

408-432-6333

800-626-4686

Web Site: <http://www.fcpa.com>

Email: [info@fcpa.fujitsu.com](mailto:info@fcpa.fujitsu.com)